

ROBOTIC VACUUM CLEANER

USER MANUAL

(Before using this product, please read the safety instructions below and follow all the routine safety precautions)

Content

1. Wi-Fi Setup Instructions

2. Safety Instructions

3. Product Components

- 3.1 Name of Parts
- 3.2 Products Specifications
- 3.3 Product feature

4. Instructions for Use

- 4.1 Attention
- 4.2 Operating Instructions

5. Product Maintenance

- 5.1 Side Brush Cleaning and Replacement
- 5.2 Cleaning of Dust Box and Filter
- 5.3 Maintenance of Water Tank Components
- 5.4 Maintenance of Rolling Brush Components
- 5.5 Maintenance of Other Components

6. Common Faults

- 6.1 Common Faults
- 6.2 Replaceable Modules

Wi-Fi Setup Instructions

1

Scan QR code of Figure 1, then download and install "Tuya smart" app or Search for TuyaSmart on the App Store or Android App platforms. Then, download and install it



Scan the QR code to download

Figure 1

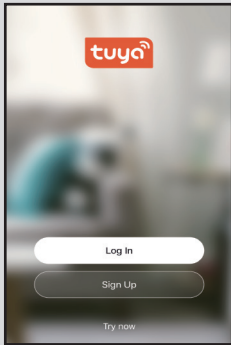

Figure 2

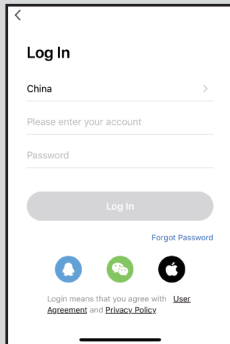

Figure 3

2

Open the Tuya smart app. If you don't have an account, please register first, then click and log in.

3

After logging in, click the "+" sign in the upper right corner of the home page to add the device. Then on the device selection page you should choose the small appliances on the left and the sweeping robots on the right. Follow the page prompts to connect.

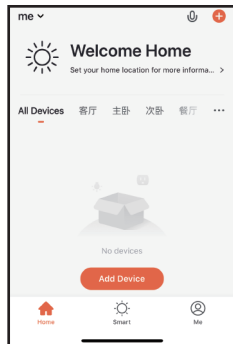

Figure 4

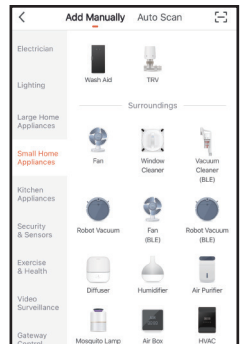

Figure 5

In order to improve the product, we reserve the right to update the app and software. The final interface is subject to the actual product, thank you.

Wi-Fi Setup Instructions

4

Click "AP Mode" in the upper right corner
Select "Confire indicator slowly blink", click "Next"

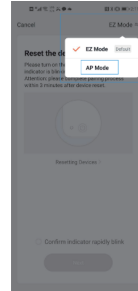

Figure 6

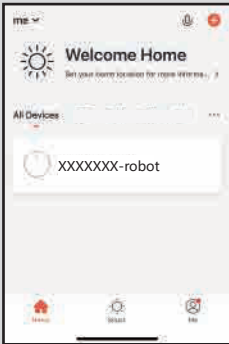

Figure 7

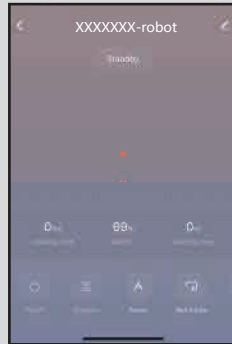

Figure 8

5

When the app displays the page shown in figure 7, you can use the app to control you sweeping robot. Click the device to enter the control interface of app . In this interface, you can select different cleaning modes, or view the cleaning process / status. Click the icon on the top right to see more options.

6

This interface can be connected to the smart audio system to realize the one key execution of multiple control functions.

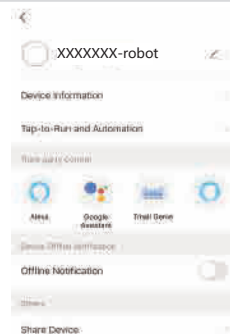

Figure 9

In order to improve the product, we reserve the right to update the app and software.
The final interface is subject to the actual product, thank you.

Safety Instruction

Before using this product, please read the safety instructions below and follow all the routine safety precautions.

Please read the instructions carefully and keep them for future reference.

Any operation that does not conform to the instructions may cause damage to the product.

Safety considerations of Main Body and Accessories

Warning

01. Do not disassemble, repair or refit the product without authorization; otherwise it may damage the product or pose a hazard.
02. Do not use the product in an environment with risk of fire or explosion.
03. This product can only use the original power adapter; otherwise the product may be damaged or catch on fire.
04. Do not stand or sit on this product; doing so could damage the product or cause it to fall over.
05. When the metal part of the power plug is dusty, please wipe it with a dry cloth.
06. The power adapter is applied to a 100-240V AC voltage. Please plug into the socket properly and keep away from children.
07. Do not wash or soak the main body and electronic accessories in the water; otherwise the product may be damaged by a short circuit.
08. Do not damage, load weight on, heat, pull, or bend it.
09. During cleaning, please pay attention to the safety of toddlers and elders at home to avoid injury. (Please pay special attention to toddlers).
10. This product is for home use. Please do not use it outdoors.
11. Do not allow metal and conductive materials to come in contact with the battery; doing so may cause a short circuit.

Attentions

01. Do not touch the product with wet hands; doing so may cause an electric shock.
02. Please do not place the product in places where it could easily fall, such as tables, chairs, high platforms in room, etc.
03. The product has a sophisticated design and should be protected from long-term exposure to sunlight.
04. Please do not use the product in humid environments, such as bath-rooms.
05. Please do not place the product near cigarette butts, lighters or other open fires.
06. Please clean the product after finishing charging.
07. Please turn on the power switch on the side of the robot when the product is out of service for a long time.

Safety Instruction

08. Please check carefully to see if the power adapter is connected to the socket prior to use, to avoid damage to the robot.
09. Before using the product, please remove all vulnerable items on the floor, such as glass, lamps, and items such as wires and curtains that may entangle with the side brush and suction passages.
10. When the dust box is full, please empty it before using again.
11. Please do not use the robot to clean the construction waste.
12. Before the product is scrapped, please remove the battery from the robot. When you remove the battery, please ensure that the product is not connected to a power supply. Please recycle the battery safely for environmental protection.

Safety Considerations for Rechargeable Battery

⚠ **Danger**

01. Always use a dedicated battery adapter to avoid leakage, heating or rupture.
02. Do not short-circuit the battery or remove the battery; doing so may cause leakage, heating or rupture.
03. Do not transport or preserve with necklaces, hairpins, and other metal objects; doing so may lead to short circuit, resulting in leakage, heating or rupture.
04. Do not burn or heat the battery; doing so may cause leakage, heating or rupture.

⚠ **Attention**

01. If abnormal overheating is discovered during charging, stop using it immediately to avoid leakage, heating or rupture.
02. To prolong the service life of the battery, please remove the battery and place it in a cool, dry environment if it is out of service for a long time; this will avoid leakage, heating or rupture.
03. Do not soak in water or let it come into contact with any liquid; otherwise it may cause leakage, heating and rupture.
04. Be sure to stop using it immediately in case of any exception (e.g. discoloration or deformation), to avoid leakage, heating and rupture.
05. Always use tape to insulate the battery's electrode when recycling or disposing of it.
06. If the battery leaks, wipe it clean with a dry cloth, recycle it in time, or discard it.
07. Put the recycled batteries in the recycling bins set up by the community, hotels, schools, large shopping malls, supermarkets, etc or the hazardous trash can collected by professional recycling agencies. Discarded product batteries must be removed and discarded in accordance with local laws and regulations.

Safety Instruction

Warning

01. When skin or clothing is exposed to the battery electrolyte, immediately wash with clean water to avoid inflammation of skin, etc.
02. Do not use the rechargeable battery on other devices. This battery is only suitable for this robot.
03. If the battery's outer box is found to be deformed and expanded, or leakage of electrolytes is found, do not charge or continue to use to avoid danger.
04. Do not throw or inflict a strong impact on the battery; doing so may cause leakage, heating and rupture.
05. Do not disassemble the battery pack; doing so may cause battery rupture and electrolyte outflow, leading to fire, explosion and other dangers.

How to remove the battery

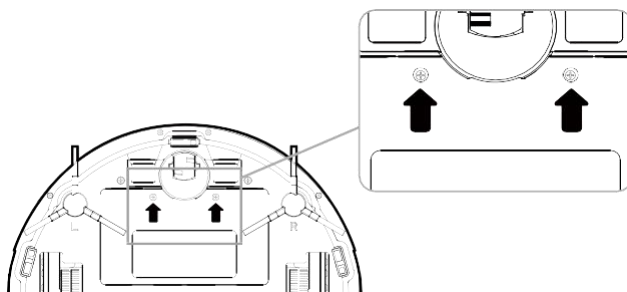

01. Take out two screws on the battery cover with a screw driver.
02. Take out the battery cover.
03. Take out the battery and unplug the electric wires to remove the battery.

Product Components

3.1 Name of Parts

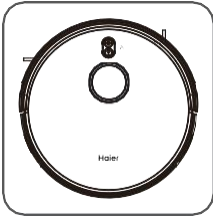

Main Body

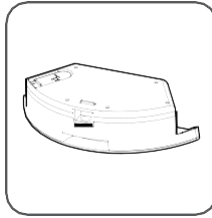

Water Tank Component

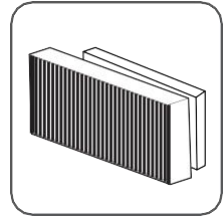

High-efficient Filter

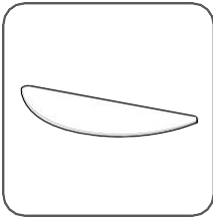

Mop

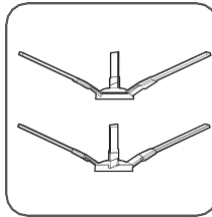

Side Brushes

Accessories of some models may be slightly different and they are subject to the actual received products.

Product Components

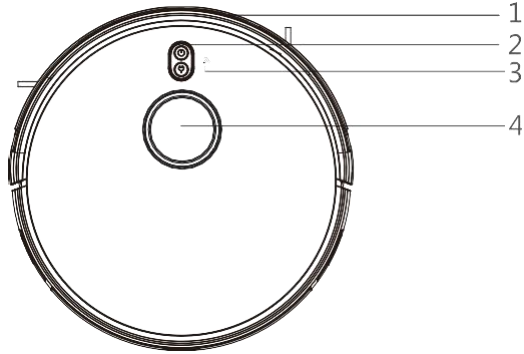

Main Body

1. Bumper 2. Control Button 3. WIFI Indicator 4. Laser Components

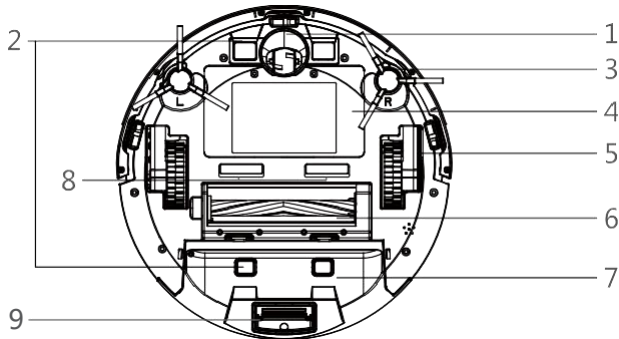

Main Body

1. Universal Wheel 2. Electrode Slice 3. Side Brush 4. Battery Cover
 5. Side Wheel 6. Suction Port 7. Dust box 8. The UV lamp
 9. Dust collection port

Product Components

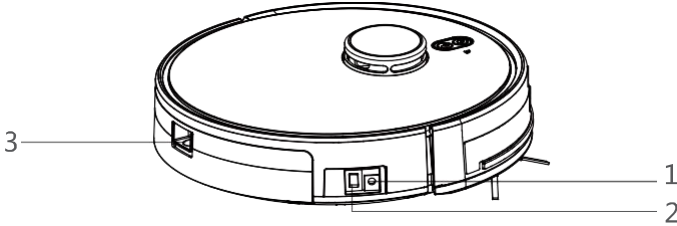

Main Body

1.DC PowerJack

2.Power Switch

3.Dust box/Water tank release botton

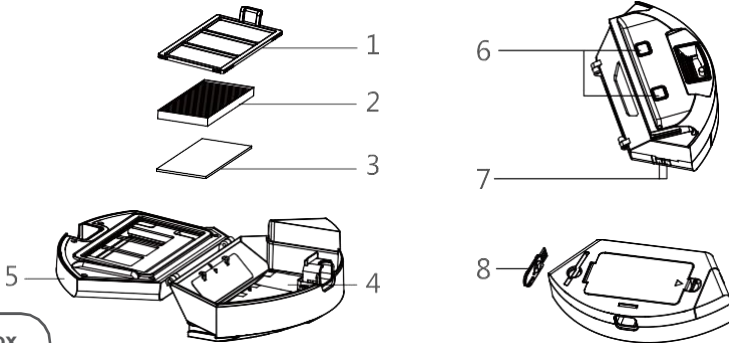

Dust Box

1.Pre-filter

2.High-efficient filter

3.Filter sponge

4.Dust Box

5.Dust box cover

6.Dust box contact sheet

7.Dust box conducting sheet

8.Cleaning Tool

Product Components

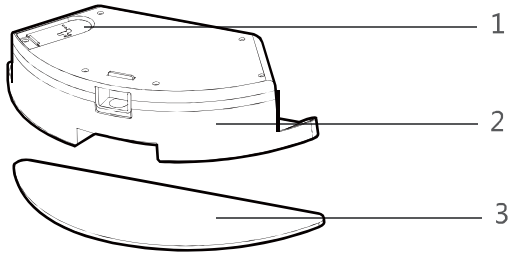

Water Tank Component

1. Tank sealing cap

2. Water tank

3. Mop

Product Components

3.2 Product Specification

Structure

Diameter of the main body	330mm
Thickness of the main body	101mm
Net weigh of the main body	3.1kg

Electronic

Voltage	14.8V
Battery capacity	5200mAh
Main body button type	LED button

Accessory

Water tank capacity	350ml
Dust box capacity	600ml
Cleaning cloth (polyester cotton)	295X100X4mm

Process Parameters

Charging Type	Manual/Automatic
Operating Duration	Approx.150-200min
Charging duration	300-360min

Product Components

3.3 Product Characteristics

Multiple smart cleaning modes

4 cleaning modes are designed to suit diuerent needs, which can be switched by the remote controller and App, greatly improves the cleaning efficiency and saves 30% of the power.

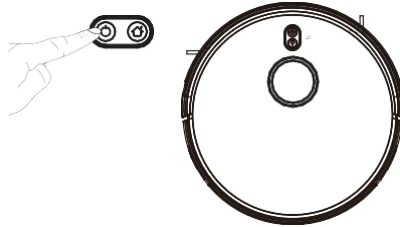

Humanized design

It is simple to operate, pressing the Control Button to start cleaning. Follow the Voice Prompt and let the robot start working for you.

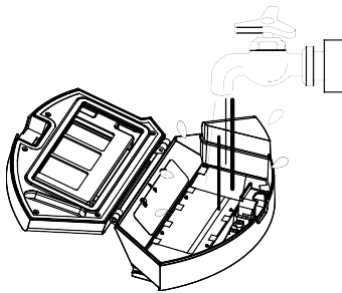

Dust box can be washed with water

The dust box and the pre-filter can be directly flushed with water without too much labor, which can avoid secondary pollution caused by dust flying!

Instructions for Use

4.1 Attention

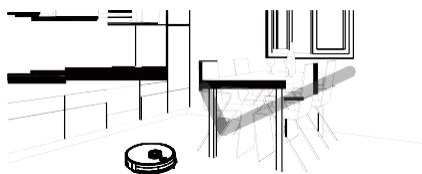
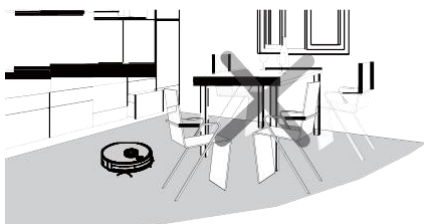

When it is working, please help to remove the unfriendly obstacles. Put the furniture and home appliances such as tables and chairs in the house neatly, the robot will clean up smoothly to give you a clean new home.

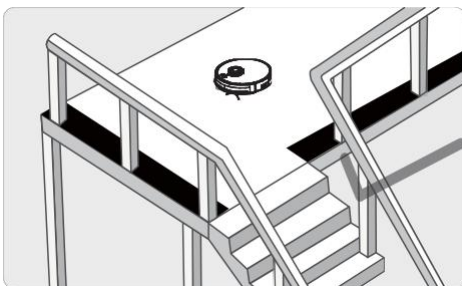
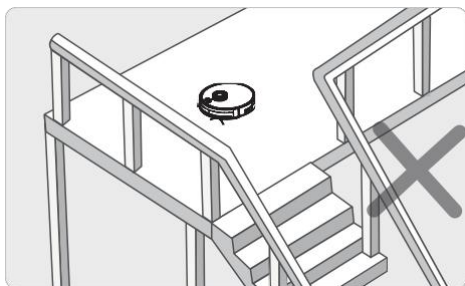

If the robot works at the stairway, the edge of the step, or the entrance to the narrow area among the furniture, etc, please place a fence to ensure it is safe and running smoothly.

Instructions for Use

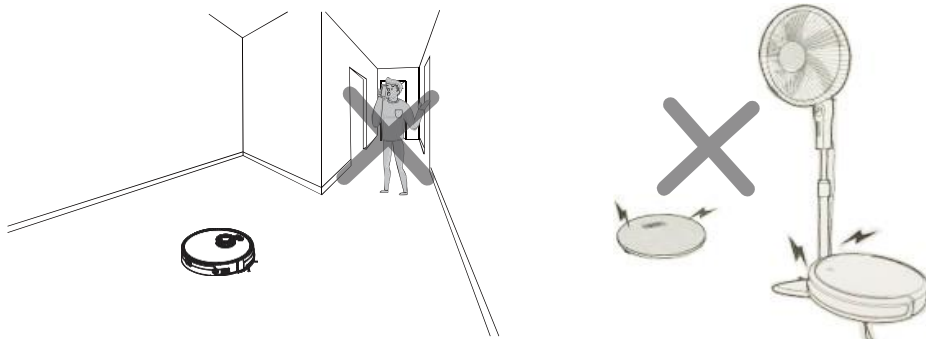

Please do not stand in narrow places such as thresholds and aisles to avoid missing sweeping. When the robot is working, please ensure that the object with the thickness less than 1.8 cm is not placed in the cleaning area to prevent the machine from climbing and jamming.

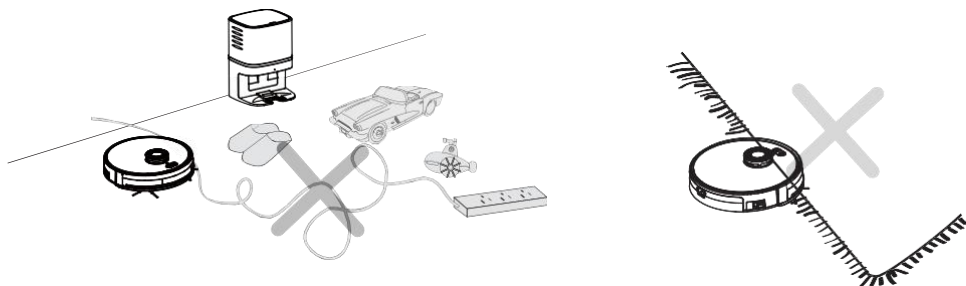

Please pay attention to remove sundries, such as the power cords, toys, etc, which are scattered on the ground may catch or entangle the Robot.
Do not use the mopping function on the carpet! If there is a carpet in the house, please roll up the edge of the carpet in advance.

Instructions for Use

4.2 Operating Instructions

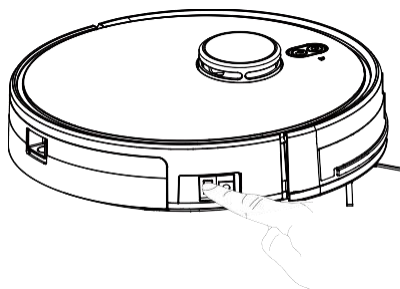

Switch on the robot, then the Control button will turn on the white light, and enter the Selected mode. if the Robot is not activated within 10 minutes, the robot will enter Sleep mode.

Charging modes

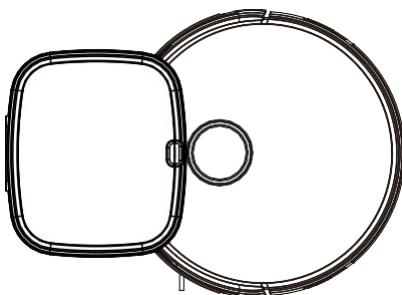

Please keep the power switch turned on before charging the machine.

Press Recharge icon on App to auto dock the Robot with the charging base.

Instructions for Use

Automatic Recharge

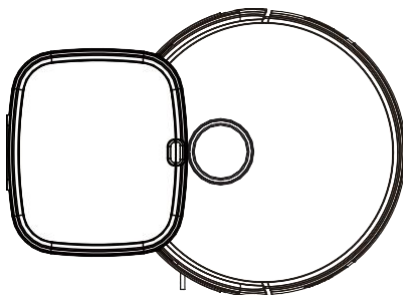

This product conforms to European ERP energy consumption standard

When Cleaning is completed or the battery is too low, the robot will automatically start finding the charging base to charge itself.
Pls keep the charging base in power, otherwise the machine will not be able to find the charging base.

Charging instruction

01. For the very first operation, please let the robot run out of power.
02. Please charge the robot for 12 hours for the first time of operation. When the charge is done, the Control button light turns on.
03. If the robot is out of service for a long time, please turn on the power switch.
04. Please charge the robot as soon as possible after the battery is used up.
05. The product can only use the power adapter and charger provided by the factory.
06. The battery should be repaired and replaced by the after-sales service center.

Instructions for Use

Switching Modes

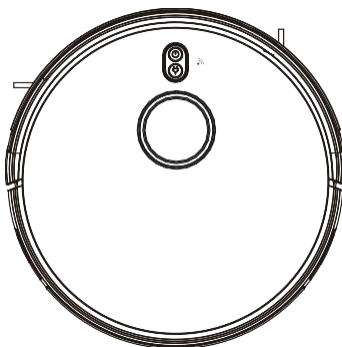

Power on

01. Make sure the power switch on the side of the robot is turned on.
02. Press the Control button “⏻” or the Cleaning mode on the remote controller to run the robot.

Pause

The pause function is to switch the robot from the operating mode to the selected mode, and the robot can be paused by the following operations:

01. Press the “⏻” button on the robot to pause the robot.
02. Press the power on/ou button on the remote controller to pause the robot.

Notice: After the machine is paused, the machine can be re-operated.

Sleep

Sleep mode means that the robot is stopped and the indicator light is out. If the Robot is not active within 10 minutes, the robot will enter Sleep mode automatically.

Note: If the robot is out of service for a long time, please turn on the power switch.

Instructions for Use

Use of Water Tank

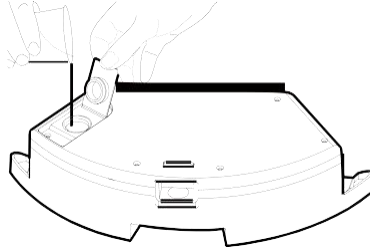

When charging, please remove the water tank to avoid danger

How to add water

Open the tank sealing cap, fill it with enough water and slowly inject water

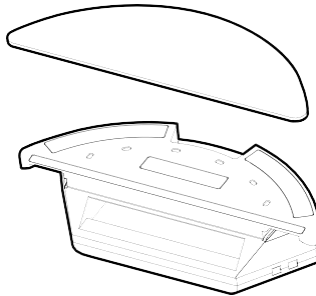

When charging, please remove the water tank to avoid danger

How to fix the microfiber mop?

Seal the tank sealing cap, then fix the microfiber mop to the velcro on the bottom of the water tank

Instructions for Use

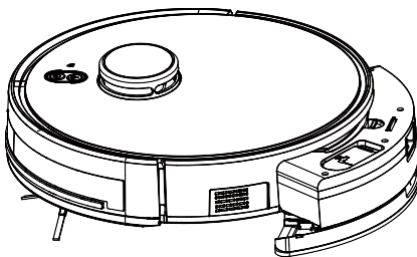

When charging, please remove the water tank to avoid danger

How to install the water tank?

Press the release button on the dust box to remove it then install the water tank

Instructions for Use

Relocation by LDS

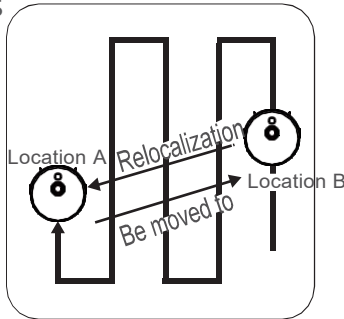

In the process of cleaning, if you move the sweeper to a new place after suspension, and restart it, it seeks to relocate. If the relocation is successful, the sweeper continues to clean. If it fails, the previous cleaning map will be lost, it will restart a new cleaning.

Spot cleaning

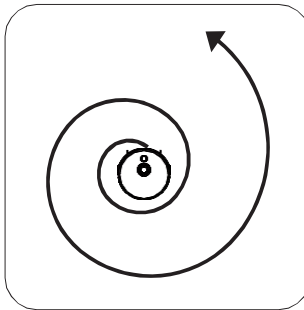

The robot will take its current position as the center and clean a specific spot of your home according to a spiral route.

Product Maintenance

5.1 Side brush cleaning and replacement

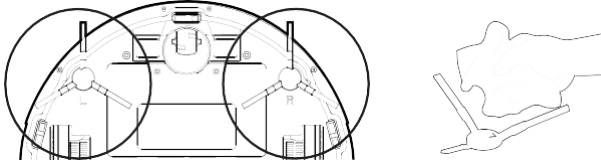

Check the side brush condition from time to time to see if it has been damaged or wrapped with foreign objects. Clean the side brush with a cleaning tool or a rag. When the side brush is damaged and cannot be used, please replace it in time, L and R side brush should be corresponding.

5.2 Dust box and filter cleaning

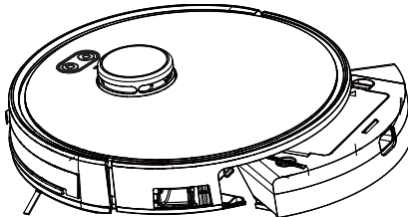

Press the dust box release button to remove the dust box

Product Maintenance

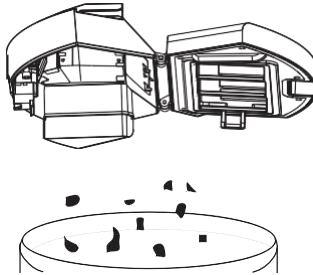

Open dust bin cover, and dump garbage

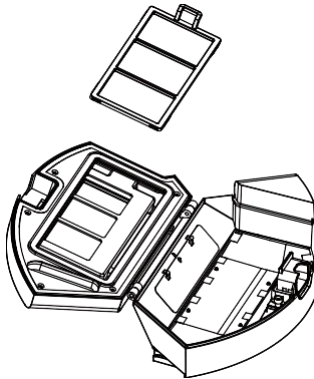

Remove the primary filter

Product Maintenance

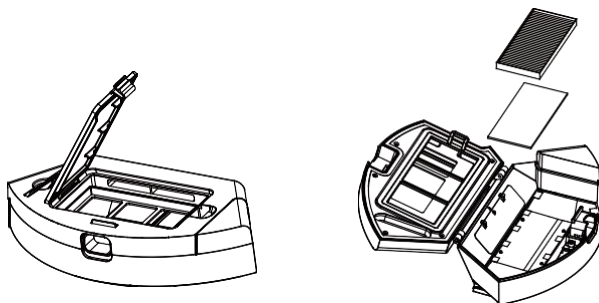

Open the high-efficient filter cover, and remove the high-efficient filter and filter sponge. It is not recommended to wash the high-efficient filter with water. Please put out the debris carefully.

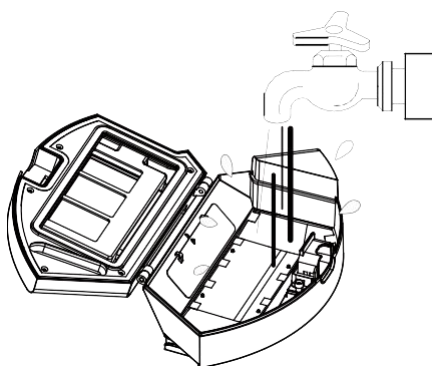

Wash the dust box and pre-filter.

Product Maintenance

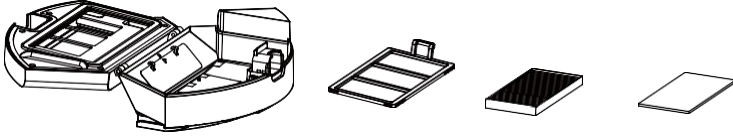

1. Dry the dust box and filter components. Keep them dry to ensure a longer service.
2. After the pre-filter is used for 15-30 days, it should be washed once.
3. The maximum service life of the high-efficient filter is 3 months.

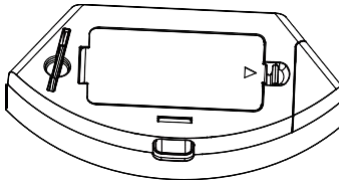

1. Reinstall the pre-filter and high-efficient filter in the dust box.
2. Before installing the filter, make sure that the high-efficient filter and the pre-filter are dry.
3. Do not expose the high-efficient filter and the pre-filter to sunlight.

Product Maintenance

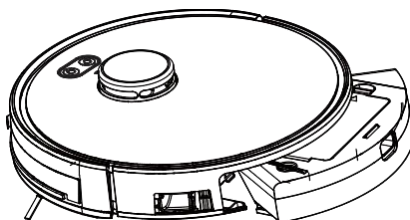

Cover the dust box and fix it into the main body.

5.3 Maintenance of Water Tank

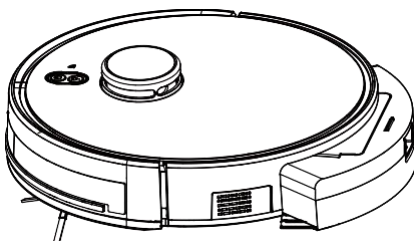

Press the release button to take out the water tank.

Product Maintenance

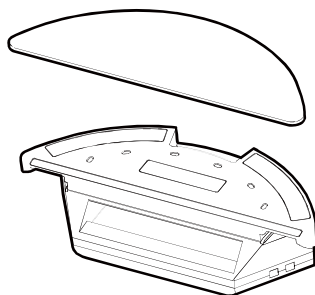

Remove the mop

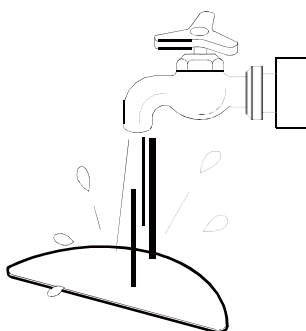

Wash and dry th

Product Maintenance

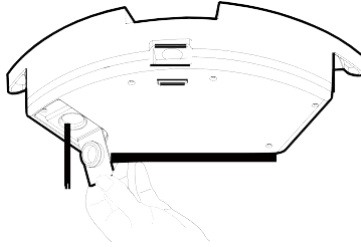

Pour out the rest of water from the water tank

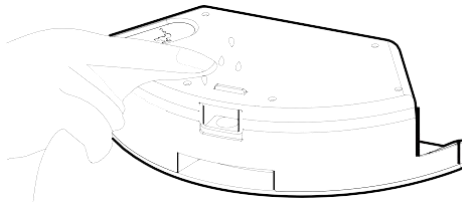

Clean the water tank and dry

Product Maintenance

5.4 Maintenance of Rolling Brush Components

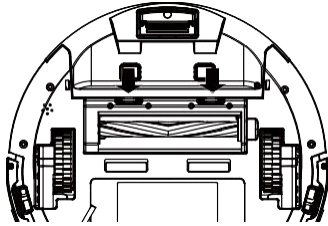

Open the rolling brush components

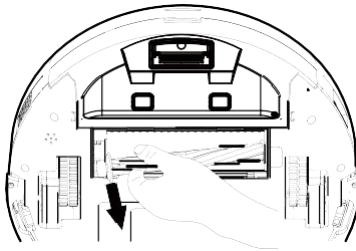

Remove the rolling brush and clean ou all debris and hair.

Product Maintenance

5.5 Maintenance of Other Components

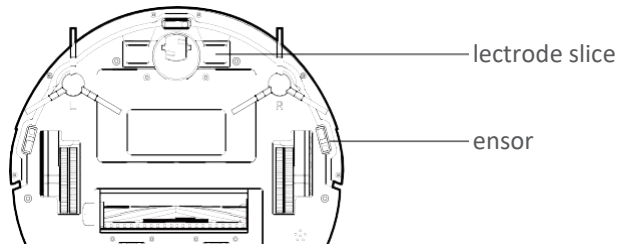

Use the cleaning tools or a dry soft cloth to periodically clean the electrode slice of robot chassis and the sensor window.

Common Faults

6.1 Faults Description

Faults	Possible Reasons	Solutions
The robot can not be charged.	The electrodes between the main body and the charging base are not contacted properly.	Make sure that the electrodes between the main body and the charging base are properly contacted.
	The charging base is switched off while the robot is switched on, which leads to the loss of power.	Keep charging the robot when it is not working to better prepare for next cleaning assignment.
The robot is stuck during work.	The robot may be stuck by wires/cables on the ground, hanging curtains or obstacles around the carpets.	The robot will try to get itself out automatically. However, please help it manually if it failed.
The robot goes back to recharge without finishing the cleaning work.	The robot detects that the power may be not enough and automatically goes back to recharge.	Charge the robot.
	The robot works at different speeds on different floor types. For example, it works longer on the wood floors than on carpets.	The length of working time varies because of the complexities of room environments, the amount of garbage and different cleaning modes.
The robot does not perform cleaning work automatically as scheduled	The robot is not switched on and the robot can not perform cleaning work as scheduled when it is powered off.	Turn on the robot.
	The power level of the robot is too low to work.	Keep charging the robot when it is not working to better prepare for next cleaning assignment.
	The robot is stuck or twined by obstacles.	Turn off the robot and clean the dust box. Then turn over the robot to clean its components, such as wheels and side brushes.
Remote control malfunctions (effective range is 5 m)	The remote controller is short of or out of power.	Change the batteries and install the batteries correctly.
	The robot is short of or out of power.	Make sure that the robot is switched on with enough power for operation..
	The infrared ray is blocked because the infrared emitter on the remote controller or the infrared receiver in the robot is contaminated.	Wipe the infrared emitter on the remote controller or the infrared receiver on the robot with a clean cotton cloth.
	Interference emitted by other devices that exist nearby.	Avoid using the remote controller near other infrared devices.
When the robot is working, there is a missed sweep, the route is chaotic, the deviation is reversed, and the APP side cleaning map shows irregularities and is not neat.	The drive wheel and the ground may slip due to the robot climbing small steps, thresholds and door bars, thus affecting the its judgment on the working environment of the whole house.	It is recommended to close the door in the area and clean the area separately. The robot has the function of self-identification single room. It will return to the starting.
	Work on a waxed, polished floor or smooth floor tile, resulting in reduced friction between the drive wheel and the ground.	It is recommended that you clean the floor after the wax is air-dried.
	The wires, slippers, etc. placed on the ground affect the normal operation of the robot.	Before the machine is working, please arrange the scattered wires, slippers and other objects on the ground to minimize the scattered objects on the ground.

Common Faults

6.2 Replaceable Modules

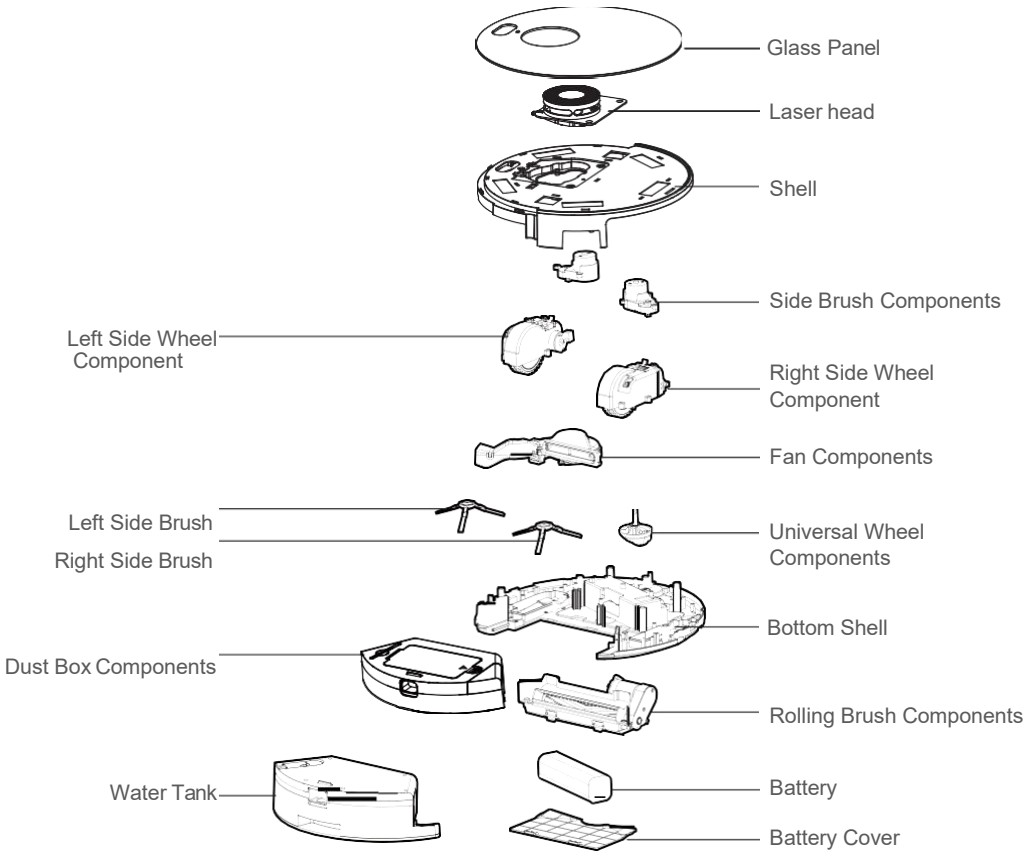

Application:

The product is suitable for cleaning house, hotel rooms, and small offices and provides good cleaning for various floors, such as wooden floor, hard floor, tile floor, and short-pile carpets (short-pile should be shorter than 1.5cm), etc.

Your Partners For a Cleaner Home



Importer: Bright star consulting e.K.

Address: Humboldtstr.5, 31812 Bad Pyrmont Germany

Manufacturer: Hangzhou Jumei E- commerce Co.,Ltd

Address: Room 301, 3rd Floor, Building 6, No. 212, Zhenhua Road,
Xihu District, Hangzhou City, Zhejiang Province

www.neatsvor.com service@neatsvor.com
